

HUSKY 510



Gebrauchsanleitung

Komfort-Schiebe-Befestigung
mit DuoLift Zentralverriegelung

Instructions for use

Comfort sliding fitting
with central locking system

Instructions d'utilisation

Montage glissé facile
avec verrouillage centralisé

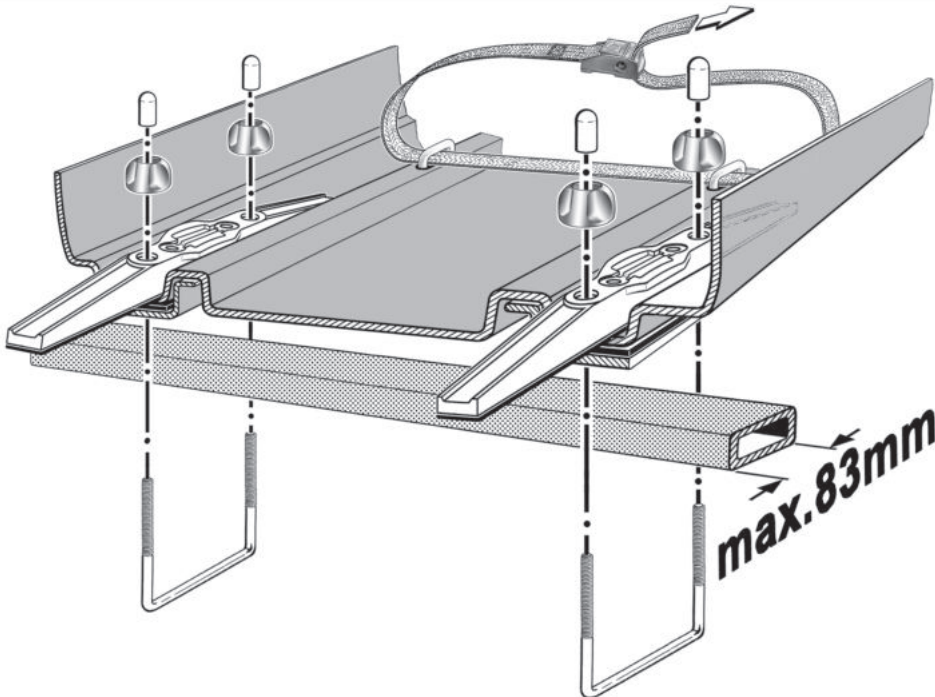
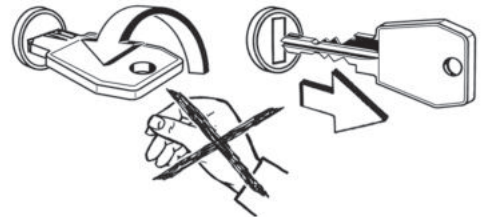
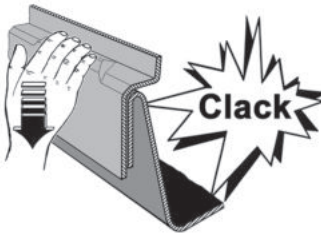
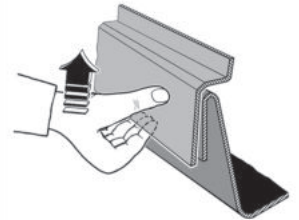
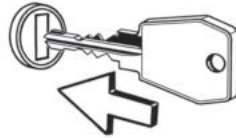
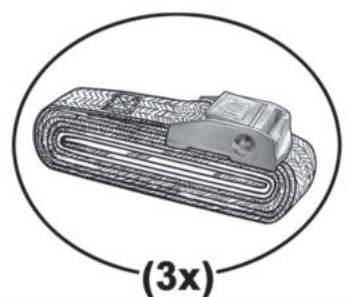
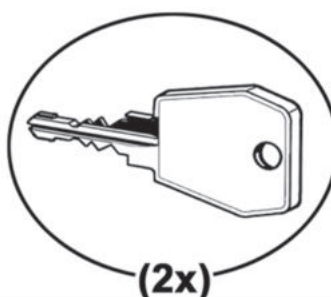
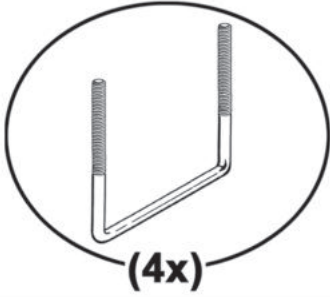

Art.-Nr. 0 52003 10
0 52005 10

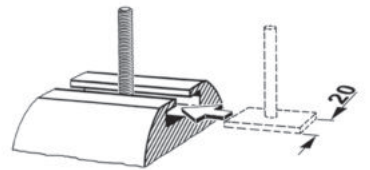

Art.-Nr. 0 52004 10

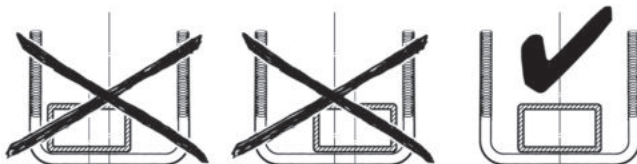
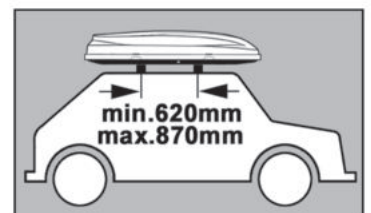
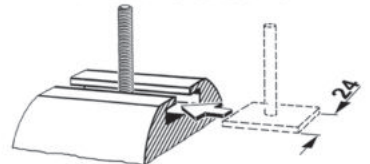

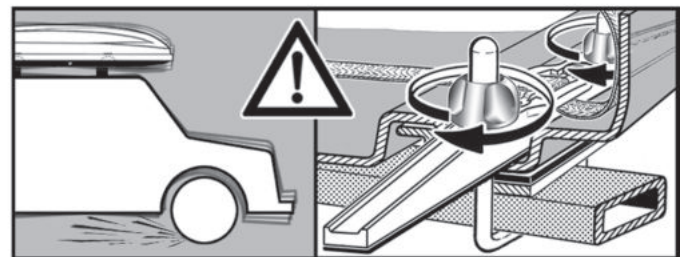
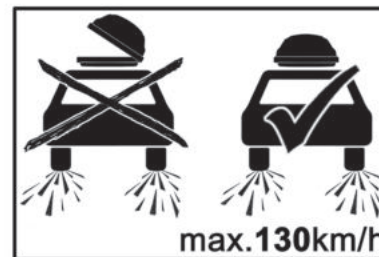
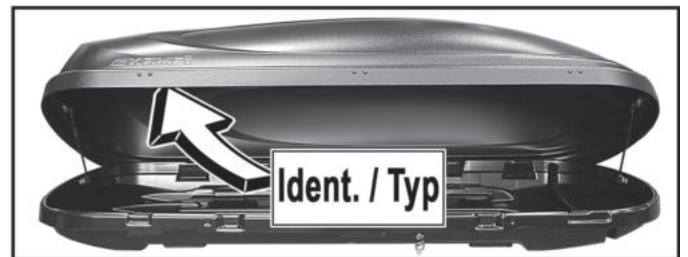
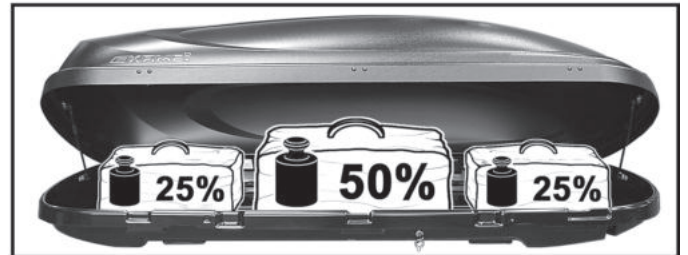
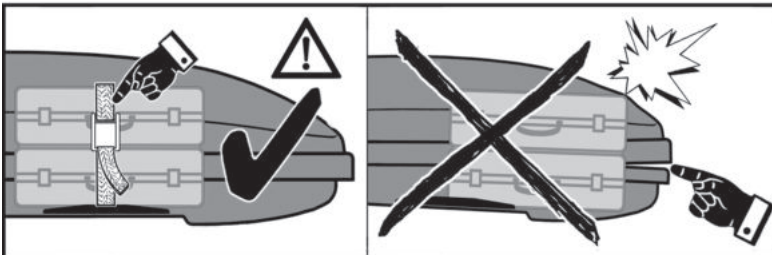
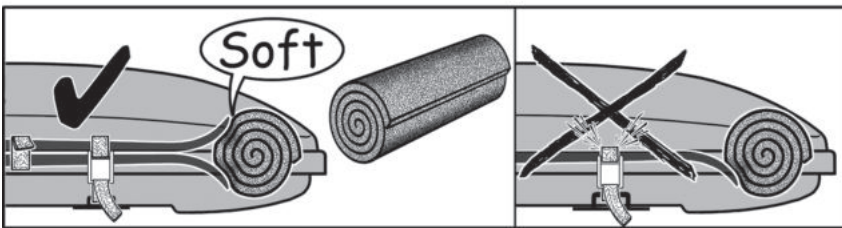
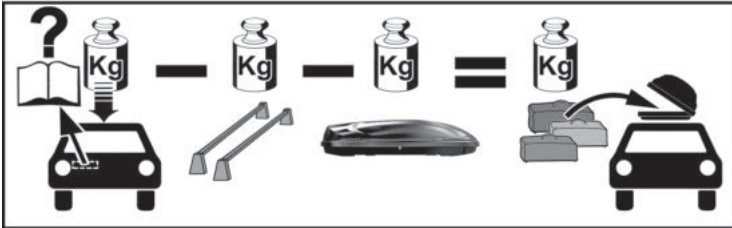
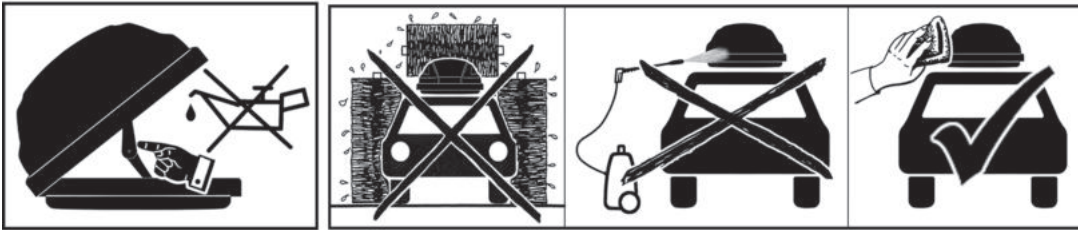
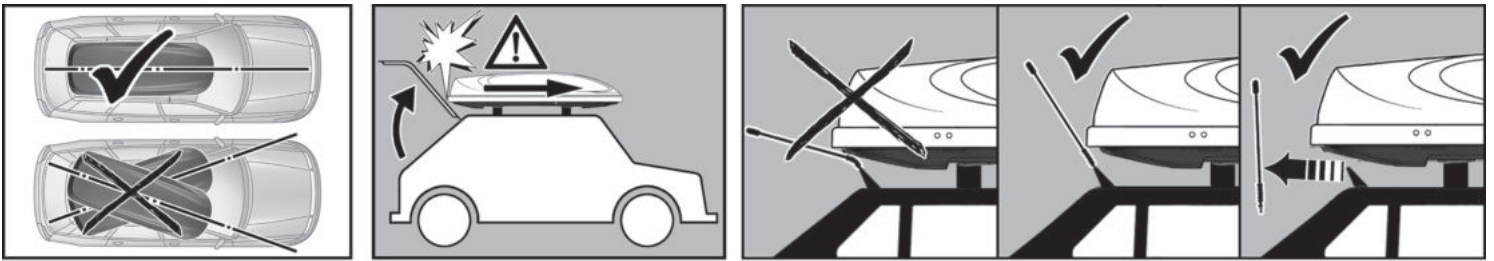

Dachcontainer Typ 81200

Haupt-Verkaufsbezeichnung Auch andere Verkaufsbezeichnungen sind genehmigt	Maße			Volumen Schüttgut Liter	Gewichte		
	Länge cm	Breite cm	Höhe cm		Eigengewicht kg	zulässige Tragfähigkeit kg	Maximalgewicht beladen kg
Husky 510 schwarz - matt	200	90	44	510	18	75	93
Husky 510 schwarz - hochglanz	200	90	44	510	19	75	94

Hersteller: KAMEI