

# DWA 1100

8-CCD WHEEL  
ALIGNMENT  
FOR CAR AND  
LIGHT TRUCK



# CEMB

# DWA 1100

**LITHIUM BATTERIES:** 24 hours of work, 1 year guaranteed  
**FEATHERWEIGHT SENSORS:** only 2.6 kg  
Immediate connection with innovative **BT<sup>2</sup> wireless communication**  
**SILICON ACCELEROMETER:** shock-proof  
**DIRECT RECHARGE OF SENSORS:** no need to disassemble them  
Designed to fit also SUV tyres: **NO EXTENSIONS REQUIRED**  
Truck and bus wheel alignment **AVAILABLE WITH SMALL EXTRA CHARGE**  
**SUNLIGHT FILTER:** over 12 m wheelbase even in outdoor sun exposed environment  
Simple and **user-friendly software**

**BATTERIE AL LITIO:** 24 ore di lavoro, garanzia 1 anno  
**RILEVATORI PESO PIUMA:** solo 2.6 kg  
Connessione immediata con l'innovativa **comunicazione senza fili BT<sup>2</sup>**  
**ACCELEROMETRO IN SILICIO:** insensibile agli urti  
**RICARICA DIRETTA DEI RILEVATORI:** nessuna necessità di smontarli  
Adatto anche per pneumatici SUV: **NON RICHIEDE ESTENSIONI**  
Allineamento autocarro e bus **POSSIBILE CON PICCOLO SOVRAPPREZZO**  
**FILTRO SOLARE:** passo oltre 12 m anche in ambienti aperti e soleggiati  
**Software** semplice e **intuitivo**

**BATTERIES AU LITHIUM:** 24 heures de travail, garantie 1 an  
**DÉTECTEURS ULTRA LÉGERS:** 2.6 kg seulement  
**Connexion avancée immédiate sans fils BT<sup>2</sup>**  
**ACCÉLÉROMÈTRE EN SILICIUM:** insensible aux chocs  
**RECHARGE DIRECTE DES DÉTECTEURS:** pas besoin de les désassembler  
Adapté également aux pneumatiques de SUV: **NE NÉCESSITE PAS D'EXTENSIONS**  
Alignement camions et autobus **POSSIBLE AVEC UNE PETITE MAJORATION DE PRIX**  
**FILTRE DE SOLEIL:** empattement de plus de 12 m y compris à ciel ouvert et en présence de soleil  
**Logiciel** simple et **intuitif**

**BESONDERS LANGE LEBENSDAUER:** 24 Arbeitsstunden, 1 Jahr Garantie  
**FEDERLEICHTE MESSKÖPFE:** nur 2.6 kg Gewicht  
Übertragung der Messdaten ohne Kabel mit **BT2 sofortige Verbindung**  
**BESCHLEUNIGUNGSMESSER AUS SILICIUM:** schlagfest  
**DIREKTE AUFLADUNG VON SENSOREN:** kein Zeitverlust durch Demontage  
Für die neuen SUV-reifen dimensioniert: **KEINE VERLÄNGERUNGEN MEHR NÖTIG**  
Achsmessung von LKWs und Bussen **MIT KLEINEM PREISAUFSCHLAG MÖGLICH**  
**SONNENLICHTFILTER:** keine verlängerungen mehr nötig Achsabstand über 12 m, auch im Freien und bei Sonneneinwirkung  
Einfache und **intuitive Software**

**BATERÍAS DE LITIO:** 24 horas de trabajo, garantía 1 año  
**CAPTADORES PESOS PLUMA:** sólo 2.6 kg  
Conexión inmediata con la innovadora **comunicación inalámbrica BT<sup>2</sup>**  
**ACELERÓMETRO EN SILICIO:** insensible a los golpes  
**RECARGA DIRECTA DE LOS CAPTADORES:** ninguna necesidad de desmontarlos  
Adecuado también para neumáticos SUV: **NO NECESITA EXTENSIONES**  
Alineación camión y bus **POSIBLE CON UN PEQUEÑO SOBREPREGIO**  
**FILTRO SOLAR:** paso superior a 12 m también en ambientes abiertos y soleados  
**Software** sencillo y **fácil de usar**

## SOFTWARE



**FAST caster swing**  
Sterzata FAST  
Braquage FAST  
Lenkeinschlag FAST  
Viraje FAST



**Adjust two axles in one screen**  
Regolazione di entrambi gli assi in un'unica schermata  
Réglage des deux essieux sur une unique page  
Einstellung beider Achse in einem einzigen Bildschirm  
Ajuste de ambos los ejes en una única pantalla



**Direct spoiler, no extensions required**  
Funzione spoiler automatico, non richiede l'utilizzo di estensioni  
Fonction becquet automatique (ne nécessite pas l'utilisation d'extensions)  
Automatisches Spoilerprogramm Verwendung von Verlängerungen nicht nötig  
Función spoiler automático, no requiere utilizo de extensiones



**Clear help for adjustment**  
Visualizzazione in dettaglio delle regolazioni  
Visualisation détaillée des réglages  
Detaillierte Ansicht der Einstellungen  
Indicación detallada puntos de arreglo



**AUDIT function for the identification of driving problems**  
Funzione AUDIT per la diagnosi completa dei disturbi di guida  
Fonction AUDIT pour l'identification des problèmes de conduite  
Funktion AUDIT für die Diagnose der Fahrstörungen  
Función AUDIT para la identificación de problemas de conducción

## VERSIONS

### DWA1100 (with cabinet)

 **Ergonomic design**  
**Industrial computer**  
**No moving parts more likely to break**  
**Data update through USB**

 Design ergonomico  
 Computer industriale  
 Senza parti in movimento più soggette a rotture  
 Aggiornamento dati via USB

 Forme ergonomique  
 Ordinateur industriel  
 Sans disque en mouvement qui risquent davantage les ruptures  
 Mise à jour des données via USB

 Ergonomisches Design  
 Industrieller Computer  
 Ohne bewegliche Scheiben, dem stärkeren Bruch ausgesetzt sind  
 Daten-Update via USB

 Diseño ergonómico  
 Ordenador industrial  
 Sin partes en movimiento con más probabilidad de romperse  
 Actualización datos por medio de USB

### DWA1100 Light

 **No CABINET!** Save your working space with your laptop!

 **Senza ARMADIO!** Risparmi spazio di lavoro ed usi il tuo pc!

 **Sans ARMOIRE!** Gains d'espace de travail et utilisation de son propre PC!



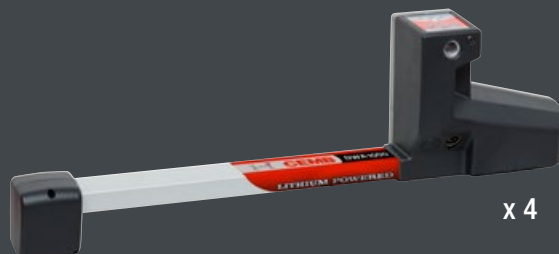

 **Ohne STEUERSCHRANK!** Sie sparen Raum und benutzen Ihren eigenen PC!

 **¡Sin ARMARIO!** ¡Ahorras espacio de trabajo y utilizas tu PC!

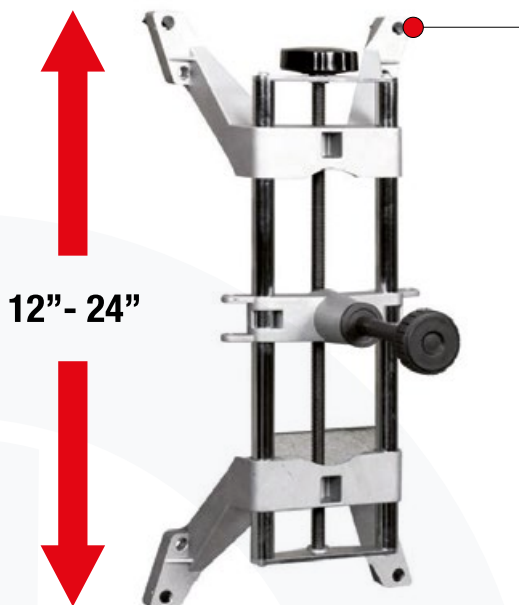





## STANDARD CONFIGURATION





 **Optional up to 30"**  
 Opzionale fino a 30"  
 Option jusqu'à 30"  
 Opzional bis zu 30"  
 Opcional hasta 30"







 **Metal 80 mm grips for 4-WD, SUV, light trucks and rims with hubcap**  
 Unghiette metalliche 80mm per 4-WD, SUV, veicoli commerciali leggeri e cerchi con coprimozzo  
 Onglets universels de 80 mm en métal, pour 4WD, SUV et véhicules de transport léger  
 Universal-Radklammerfingern aus Metall, 80 mm, für 4WD, SUV und Kleintransporter  
 Uñas universales 80 mm en metal, para todo terreno, SUV y vehiculos de transporte ligero



 **Metal 48 mm grips with reference surface to optimize runout**  
 Unghiette metalliche 48 mm con piano di riferimento per l'ottimizzazione del runout  
 Onglets de 48 mm en métal avec surface de référence pour optimiser le run-out  
 Radklammerfingern aus Metall 48mm mit Auflageoberfläche zur Reduzierung des Runout-Fehlers  
 Uñas 48 mm en metal con superficie de referimiento para optimizar el run out





## OPTIONAL ACCESSORIES







 **Clamp supporting arms and set of tips for tyres with external diameter up to 31" (with optional support arms up to 40")**  
 Bracci e gruppo di puntali per aggrappo in appoggio a pneumatici con diametro esterno fino a 31" (con bracci di supporto opzionali fino a 40")  
 Bras et groupe de broches d'accrochage en appui sur pneumatiques de diamètre externe jusqu'a 31" (avec bras de support optionnel jusqu'a 40")  
 Klemmarme und Positionsfinger für Radklammern zum Auflegen auf Reifen mit Aussendurchmesser bis zu 31" (mit optionalen Stützarmen bis zu 40")  
 Brazos y grupo de puntales para mordaza en apoyo a neumáticos con diámetro externo hasta 31" (opcional hasta 40")

### Grips for all rims and tyres are available



 **Metal grips for clamping on steel rims from the inside**  
 Unghiette in metallo per aggrappo dall'interno su cerchi in ferro  
 Onglets en métal pour accrochage de l'intérieur sur jantes en fer  
 Metallkrallen zum Halten von innen bei Eisenfelgen  
 Uñas en metal para mordaza desde el interior en llantas en hierro

## STANDARD COMPOSITION

-  Computer with WINDOWS operating system, 27" TFT monitor, colour printer, USB keyboard, mouse (only for DWA1100)  
4 car sensors  
4 clamps + safety elastic band + 2 set of grips  
2 mechanical turntables for cars  
Steering lock + Brake pedal lock  
Wheel alignment software and database for CARS
-  Computer con sistema operativo WINDOWS, Monitor 27" TFT, stampante a colori, tastiera USB, mouse (solo per DWA1100)  
4 rilevatori vettura  
4 aggrappi + elastico di sicurezza + 2 set di unghiette  
2 piatti rotanti meccanici per vettura  
Bloccasterzo + premipedale  
Software e database autoveicoli
-  Ordinateur avec système d'exploitation WINDOWS, moniteur 27", imprimante couleur, clavier USB, souris (seulement pour DWA1100)  
4 détecteurs voiture  
4 griffes + élastique de sécurité + 2 jeux d'onglets  
2 plateaux rotatifs pour voitures  
Blocage direction + presseur pédale  
Logiciel et base de données pour autos
-  Computer mit Betriebssystem WINDOWS, 27"-TFT-Monitor, Farbdrucker, Tastatur USB, Mouse (nur für DWA1100)  
4 Messköpfe für PKW  
4 Radklammern + elastisches Schutzband + 2 Radklammerfinger  
2 vordere Drehteller für PKW  
1 Lenkradfeststeller, 1 Bremspedalfeststeller  
Software und Database für Fahrzeugen
-  Ordenador con sistema operativo WINDOWS, monitor 27" TFT, impresora de color, teclado USB, ratón (solo para DWA1100)  
4 captadores coche  
4 mordazas + elástico de seguridad + 2 equipos de uñas  
2 platos rotatorios para coches  
Dispositivo antirrobo + apretapedal  
Software y base de datos para coches

## TECHNICAL DATA

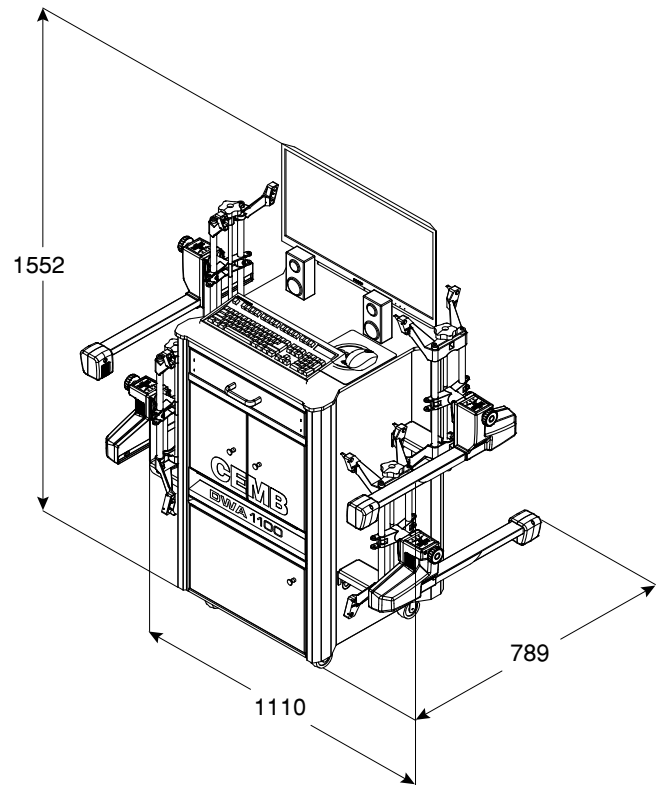

### PACKAGE DIMENSIONS AND GROSS WEIGHT:





113x113x113 cm (44,5x44,5x44,5")

220 Kg





**Net weight:** 155 Kg

## OPTIONS







-  **Premium turntables:** capacity 1000 kg per plate, Ø 35 cm, with rubber supports
-  **Piatti Premium:** portata 1000 kg per piatto, Ø 35 cm, con supporti in gomma
-  **Plateaux Premium:** portée 1000 kg par plateau, Ø 35 cm, avec supports en caoutchouc
-  **Premium-Teller:** Tragkraft 1000 kg pro Teller, Ø 35 cm, mit Auflagen aus Gummi
-  **Platos Premium:** capacidad de 1000 kg por plato, Ø 35 cm, con soportes de goma



-  **WiFi connection for automatic software updates**
-  Collegamento wifi per l'aggiornamento automatico del software
-  Connexion Wi-Fi pour la mise à jour du logiciel
-  Wifi-Verbindung zur automatischen Aktualisierung der Software
-  Conexión wifi para actualizar automáticamente el software



-  **Truck and Bus upgrade kit**
-  Kit di conversione auto/camion-bus
-  Kit de conversion auto/camion-bus
-  Pkw - Lkw Nachrüstatz
-  Equipo de conversión coche/camióbus



# CEMB

BALANCING MACHINES

**CEMB S.p.A.**

Via Risorgimento, 9  
23826 Mandello del Lario (LC) - Italy  
[www.cemb.com](http://www.cemb.com)



**Garage equipment division**  
**CEMB - ITALY**  
**Plant and Training Center**  
Phone +39 0341 706111  
[garage@cemb.com](mailto:garage@cemb.com)

**CEMB USA - BL Systems Inc.**  
2873 Ramsey Road  
Gainesville, GA 30501 - USA  
Phone +001 678 717 1050  
Fax +001 678 717 1056  
[sales@cemb-usa.com](mailto:sales@cemb-usa.com)

All the data and features mentioned in this catalogue are purely for information and do not constitute any commitment on the part of our company, which reserves the right to make any and all alterations it may consider suitable without notice.